

Graphic reference

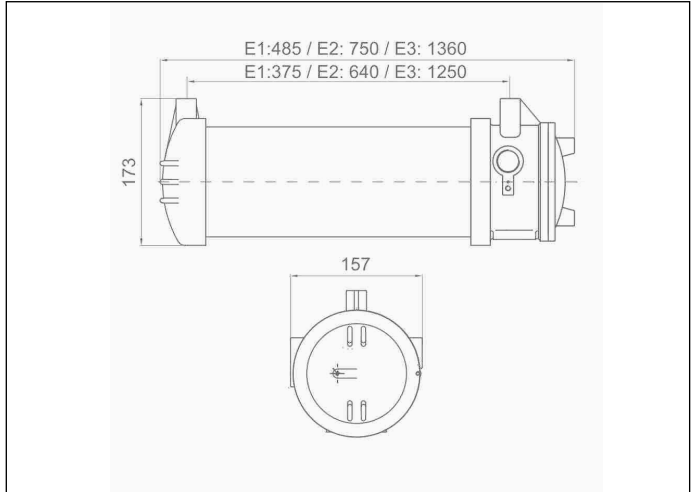

Dimensions



Control System: DALI

Luminaire: Illumination

Standards: EN-60598-1, EN 60079-0, EN 60079-1, EN 60079-31, EN61347-2-7, EN61347-2-13, EN62386

Certification: CE, IECEx INE 21.0022X, INERIS21ATEX0012X



Electrical characteristics

Supply: 220-240V 50-60Hz<40W / 220-240Vdc<40W

Maintained mode consumption: 40,0 W

Non-maintained mode consumption: - W

Working temperature: -20°C<=Ta<=+50°C

Emergency lamp: 2 X LED 16W

Emergency lumen output: - lm

Maintained lumen output: 5500 lm

Battery: -

Class: I

Mode: -

Power factor: 0.95 %

Signaling Luminaire: 220-240Vac/dc<40W

LED temperature: 4000°K

Duration: - h

Remote control: Yes

Charging time: 0 h

Mechanical characteristics

Housing: Aluminum

Diffuser: Transparent Polycarbonate

Suitable for flammable surfaces: Yes

ATEX Protection: Zona 1/Zona 21/Ex db IIC T6 Gb/Ex tb IIIC T85°C Db

ATEX Envelope: E3

IP/IK: IP66/IK10

Finish: -

ATEX: Yes

Weight: 10,30KG

Photometric curve

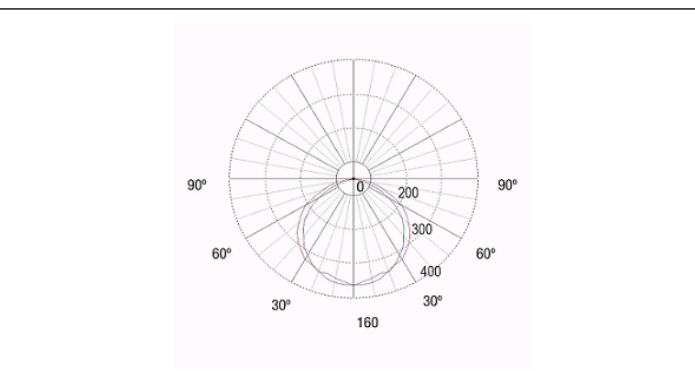

Interdistance

Installation height	Diagram 1	Diagram 2
2,0 m	-	-
2,5 m	-	-
3,0 m	-	-
3,5 m	-	-

Installation characteristics

Electrical connection by 5-pole + T connector for cable up to 2.5 mm².
The maintained luminaires have the possibility of connection to enable / disable the maintained mode.
Possibility of installation in:
 Ceiling/Wall surface with clamping flanges.
 Suspended roof, with eyebolt.
Possibility of connection with:
 Surface tube wiring.
Two 3/4" NPT entries for cable glands (not included), one of which is provided with a plug.

Operating characteristics

Valid to be supply in the following ways:
 Directly at rated voltage.

General Envelope data

Tubular diffuser:
 Borosilicate glass, E1 (7mm thick) E2/E3 (9mm thick)
 Polycarbonate, UV protected. 3mm thick.

Casting & connections:
 Aluminum injection
 Manufactured from marine grade aluminum alloy copper free
 Yellow RAL-1003 polyurethane paint
 Explosion proof O-ring.
 2 entries 3/4" NPT for cable glands (not included)
 1 plug supplied
 Electric connection through 5P+T 2,5 mm² terminal block
 Suitable for installation on flammable surfaces

Accessories

BRD001



ACC. FLANGE FOR SURF. SATURNO
CEILING MOUNTING

CAM001

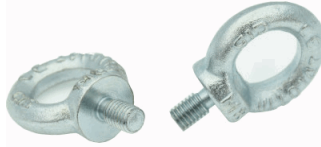

RING BOLT FOR PENDANT MOUNTING

PSA001



ACC. CABLE GLANDS SATURNO
METALLIC