

### Graphic reference

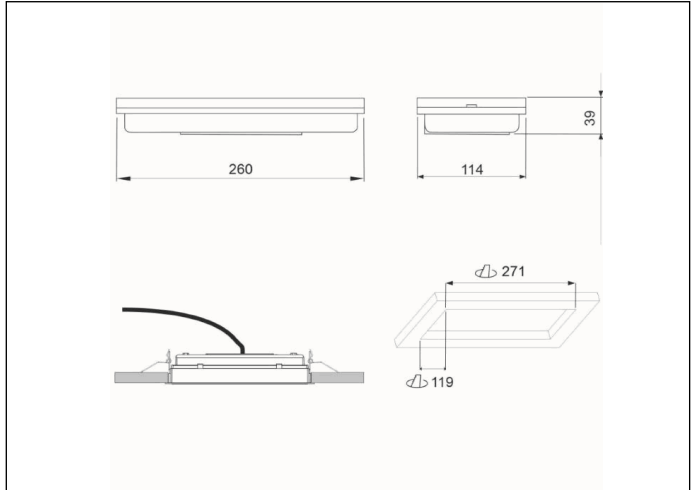

### Dimensions



**Control System:** AutoTest

**Luminaire:** Self-Contained

**Standards:** EN-60598-1,  
EN-60598-2-22, EN-62034

**Certification:** CE, ENEC



### Electrical characteristics

**Supply:** 230V 50Hz<2.2W

**Maintained mode consumption:** - W

**Non-maintained mode consumption:** 2,2 W

**Working temperature:** 0-40°C

**Emergency lamp:** 4 x LED 0.5W

**Emergency lumen output:** 225 lm

**Maintained lumen output:** - lm

**Battery:** 3.6V-0.8Ah Ni-Cd

**Class:** II

**Mode:** NM

**Power factor:** - %

**Signaling Luminaire:** -

**LED temperature:** 4000°K

**Duration:** 1 h

**Remote control:** No

**Charging time:** 24 h

### Mechanical characteristics

**Housing:** Polycarbonate

**Diffuser:** Transparent Polycarbonate

**Suitable for flammable surfaces:** Yes

**ATEX Envelope:**

**IP/IK:** IP44/IK07

**Finish:** White RAL9003

**Weight:** 0,42KG

### Photometric curve

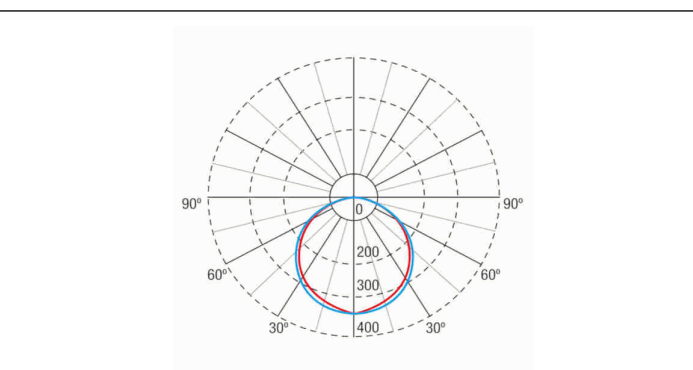

### Interdistance

**Installation height**



2,0 m	8,78 m	8,61 m
2,5 m	9,67 m	9,45 m
3,0 m	10,41 m	10,13 m
3,5 m	10,97 m	10,68 m

### Installation characteristics

Maintained luminaires have a selector bridge to enable / disable the maintained mode.

Installation with mounting plate.

Possibility of installation in:

- Ceiling/Wall surface.

- Recessed in ceiling.

- Semi-recessed in wall.

Possibility of connection with:

- Recessed wiring.

- Surface tube wiring (max. M20)

### Operating characteristics

The luminaire has status LEDs, which indicates:

- Status of the battery charging circuit.

- Battery status (duration)

- Emergency status function.

- Test status.

Microprocessor controlled luminaire that performs periodic and automatic tests.

- Functional test every 7 days.

- Duration test every 365 days.

The test result is shown in the status indicator LEDs.

### General Envelope data

### Accessories

**AMD0041**



ACC. REC. XENA FLAT WHITE  
CEILING

**ABX4071**



ACC. PANEL REC. XENA FLAT WHITE  
WITHOUT SERIG.

**AED0071**



ACC. SEMI-REC. DIANA FLAT WHITE  
WALL

**AMU8001**



ACC. FRAME REC. DIANA/XENA  
WHITE UNIVERSAL

**APT316**



ACC. PICTO. TOLEDO UNIVERSAL  
PERSON + ARROW

**APV616**



ACC. PICTO. DIANA FLAT PERSON +  
LEFT ARROW

**APV617**



ACC. PICTO. DIANA FLAT PERSON +  
RIGHT ARROW

**APV618**



ACC. PICTO. DIANA FLAT PERSON  
+UP ARROW

**APV619**



ACC. PICTO. DIANA FLAT PERSON +  
DOWN ARROW