

Graphic reference

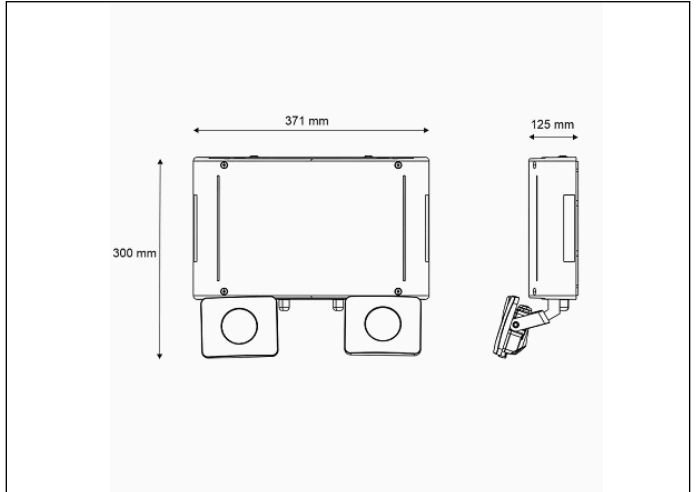

Dimensions



Control System: SmartZ

Luminaire: Self-Contained

Standards: EN-60598-1,
EN-60598-2-22, EN-62034,
ETSI EN 303 447-1

Certification: CE

Electrical characteristics

Supply: 230V 50Hz<15.0W

Maintained mode consumption: - W

Non-maintained mode consumption: 15.0 W

Working temperature: -30°C - +25°C

Emergency lamp: 2 x LEDS 20W

Emergency lumen output: 3300 lm

Maintained lumen output: - lm

Battery: 2x(12,8V-3.0Ah LFP)

Class: II

Mode: NM

Power factor: - %

Signaling Luminaire: -

LED temperature: 4000°K

Duration: 1 h

Remote control: No

Charging time: 24 h

Mechanical characteristics

Envelope: Polycarbonate

Diffuser: Glass

Suitable for flammable surfaces: Yes

ATEX Envelope:

IP/IK: IP65/IK07

Finish: Gray RAL7035

Weight: 3,80KG

Photometric curve

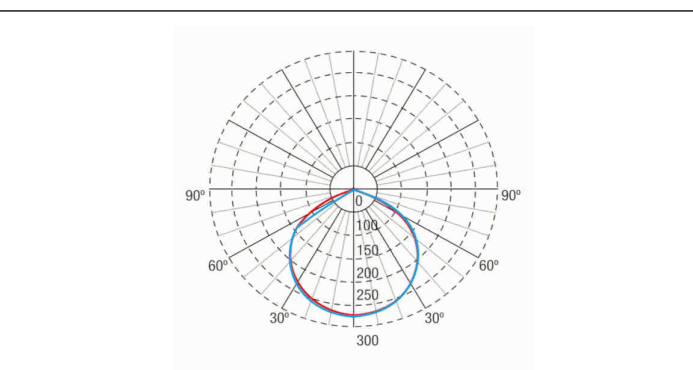

Interdistance

Installation height



2,0 m	9,79 m	8,57 m
2,5 m	12,24 m	10,71 m
3,0 m	14,69 m	12,86 m
3,5 m	17,14 m	15,00 m

Installation characteristics

Possibility of installation in:
Ceiling/Wall surface.
Possibility of connection with:
Surface tube wiring.
It has 4 pre-marked entries for PG-11 (included)
Two orientable spotlights, horizontally y vertically.
Specially designed to cover large areas and / or heights.

Operating characteristics

The luminaire has status LEDs, which indicates:
Status of the battery charging circuit.
Battery status (duration)
Emergency status function.
Test status.
Microprocessor controlled luminaire
The luminaire can be connected to a control unit.
When the luminaire is installed without a control unit, it performs periodic and automatic tests.
Functional test every 7 days.
Duration test every 365 days.
The test result is shown in the status indicator LEDs.
Wireless communication that allows: Communication with Control unit by wireless communication with a 2.4Ghz frequency system.

General Envelope data

Accessories

AGM160

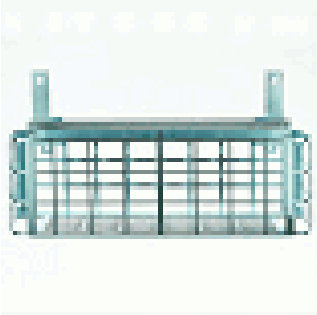

ACC. PROT. GRILLE MAXILUM EVO